

STRAINING CABLE (Fixed to wall with M10 Rawleyes)

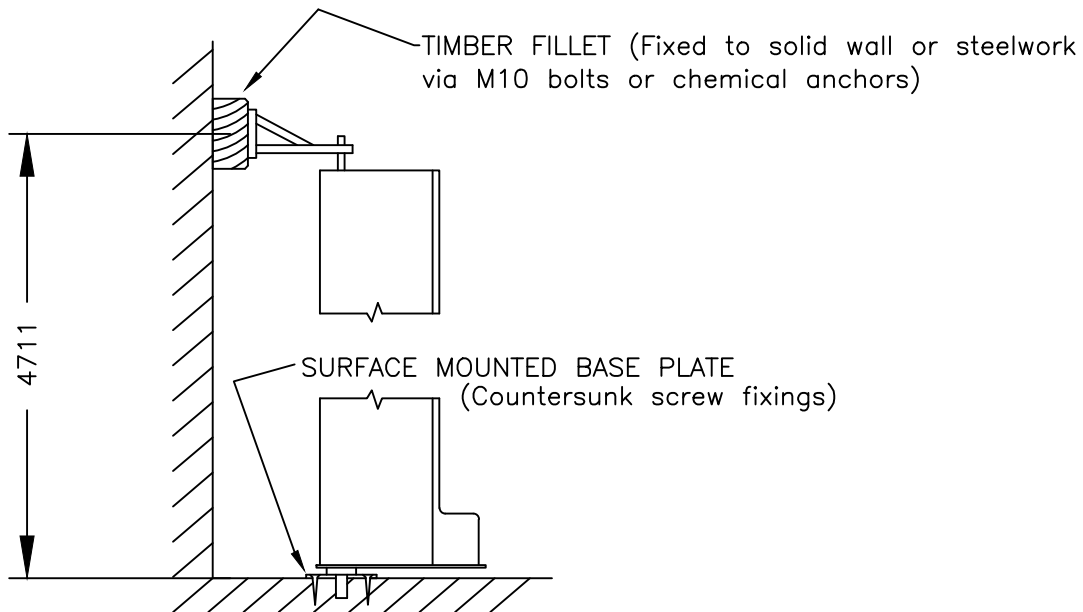

TITLE  
HINGED BEAM UNIT

INFO SHEET No.  
4431

DATE 19.7.22 ISSUE E DRAWN KT SCALE N.T.S

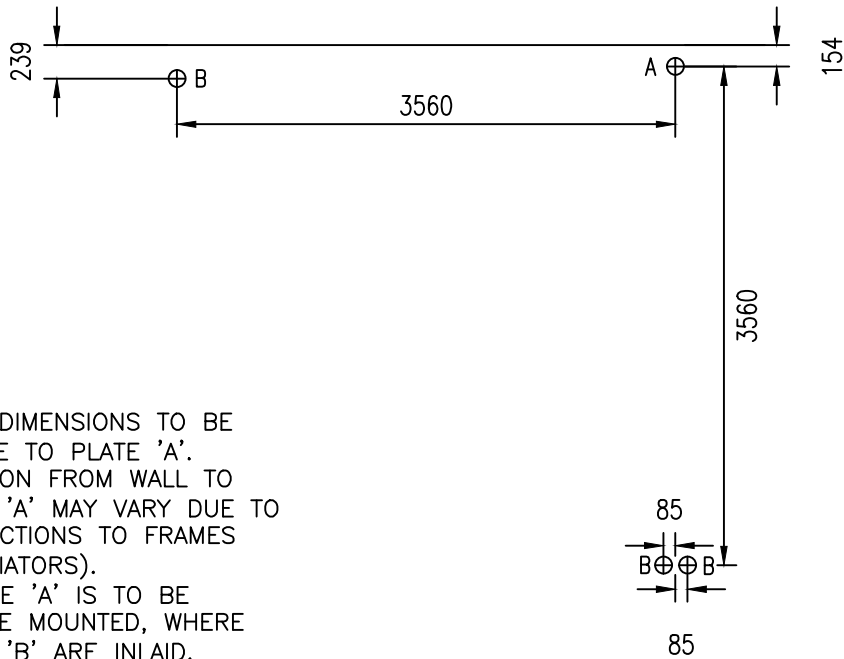

NOTES

- 1, ALL DIMENSIONS TO BE RELATIVE TO PLATE 'A'. DIMENSION FROM WALL TO PLATES 'A' MAY VARY DUE TO OBSTRUCTIONS TO FRAMES (IE RADIATORS).
- 2, PLATE 'A' IS TO BE SURFACE MOUNTED, WHERE PLATES 'B' ARE INLAID.
- 3, A 300mmx300mm PAD TO BE LEFT CLEAR OF PIPES, BASED CENTRAL AROUND FLOOR PLATE TYPES 'A' & 'B'

FLOOR PLATE TYPE A

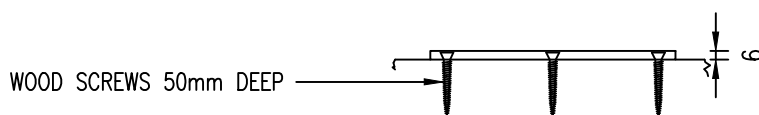

FLOOR PLATE TYPE A

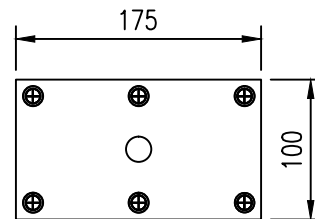

FLOOR PLATE TYPE B

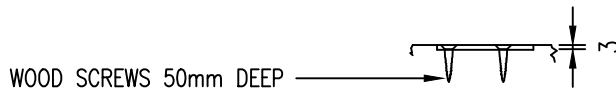

FLOOR PLATE TYPE B

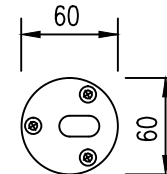

TITLE HINGE COUNTER BALANCE BEAM STANDARD  
FLOOR PLATE LAYOUT - FOLDING LEFT

INFO SHEET No. 6691

DATE 12.05.2015 ISSUE B DRAWN PS SCALE NTS

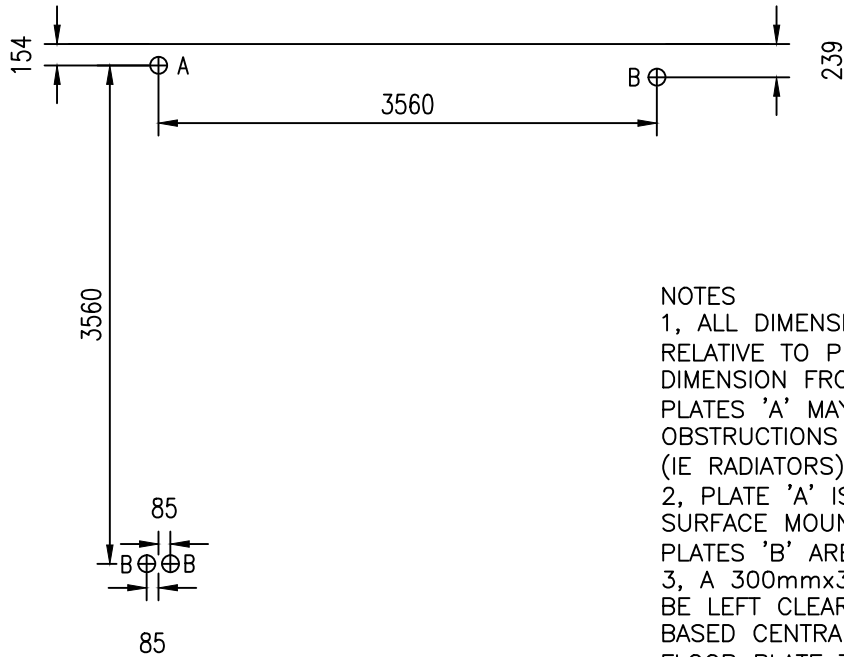

NOTES

- 1, ALL DIMENSIONS TO BE RELATIVE TO PLATE 'A'. DIMENSION FROM WALL TO PLATES 'A' MAY VARY DUE TO OBSTRUCTIONS TO FRAMES (IE RADIATORS).
- 2, PLATE 'A' IS TO BE SURFACE MOUNTED, WHERE PLATES 'B' ARE INLAID.
- 3, A 300mmx300mm PAD TO BE LEFT CLEAR OF PIPES, BASED CENTRAL AROUND FLOOR PLATE TYPES 'A' & 'B'

FLOOR PLATE TYPE A

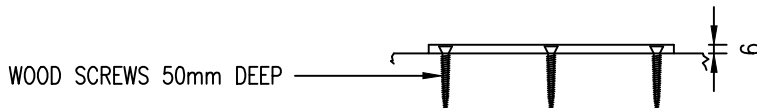

FLOOR PLATE TYPE A

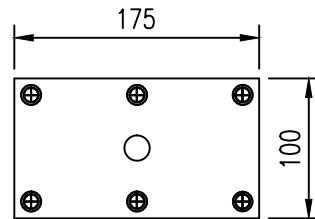

FLOOR PLATE TYPE B



FLOOR PLATE TYPE B

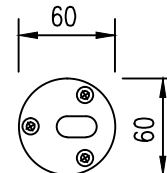

TITLE HINGE COUNTER BALANCE BEAM STANDARD  
FLOOR PLATE LAYOUT - FOLDING RIGHT

INFO SHEET No. 6701

DATE 12.05.2015 ISSUE B DRAWN PS SCALE NTS